

# Pro75<sup>®</sup> High-Power Reloadable Rocket Motor Systems

**FOR USE ONLY BY CERTIFIED HIGH-POWER ROCKETRY USERS 18 YEARS OF AGE OR OLDER**

**FLAMMABLE MATERIAL – KEEP AWAY FROM OPEN FLAME, CIGARETTES OR OTHER HEAT SOURCES AT ALL TIMES**

**USE WITHIN 1 YEAR OF MANUFACTURING DATE**

**TEMPERATURE RANGE: -5 to 30°C**

## **Read this BEFORE you start assembly:**

- If you have any questions or require assistance, please contact your dealer. If you are unable to resolve your questions or problems then please contact the manufacturer directly. Assistance is available Mon – Fri. 9am – 4:30pm at (905) 887-2370. Ask for ProXX motor products technical support.
- Read all instructions carefully and be sure you fully understand each step before proceeding with motor assembly.
- **Make sure to also read the Pro75 Product Notes for reload specific instructions. Your reload may require bonding of grains into the case liner. For moonburner reloads there are also separate moonburner instructions for gluing the grains.**
- Inspect the components of your reload kit carefully before you start assembly. DO NOT use any parts that appear damaged or faulty in any way.
- Do not tamper with or modify the hardware or reload kit components in any way. Not only will this void all product warranty, it could cause catastrophic failure of your motor system and result in damage to your rocket vehicle, launch equipment and create a hazard to persons or property.
- Reload kit components are designed for ONE USE ONLY, and may not be reused. Reuse of any of these components could result in motor failure and will void product warranty.
- Follow the safety code and all rules and regulations of your sport rocketry association. Also ensure that you are in compliance with all local, state/provincial, and Federal laws in all activities involving high power rockets and rocket motors.
- Parts checklist:

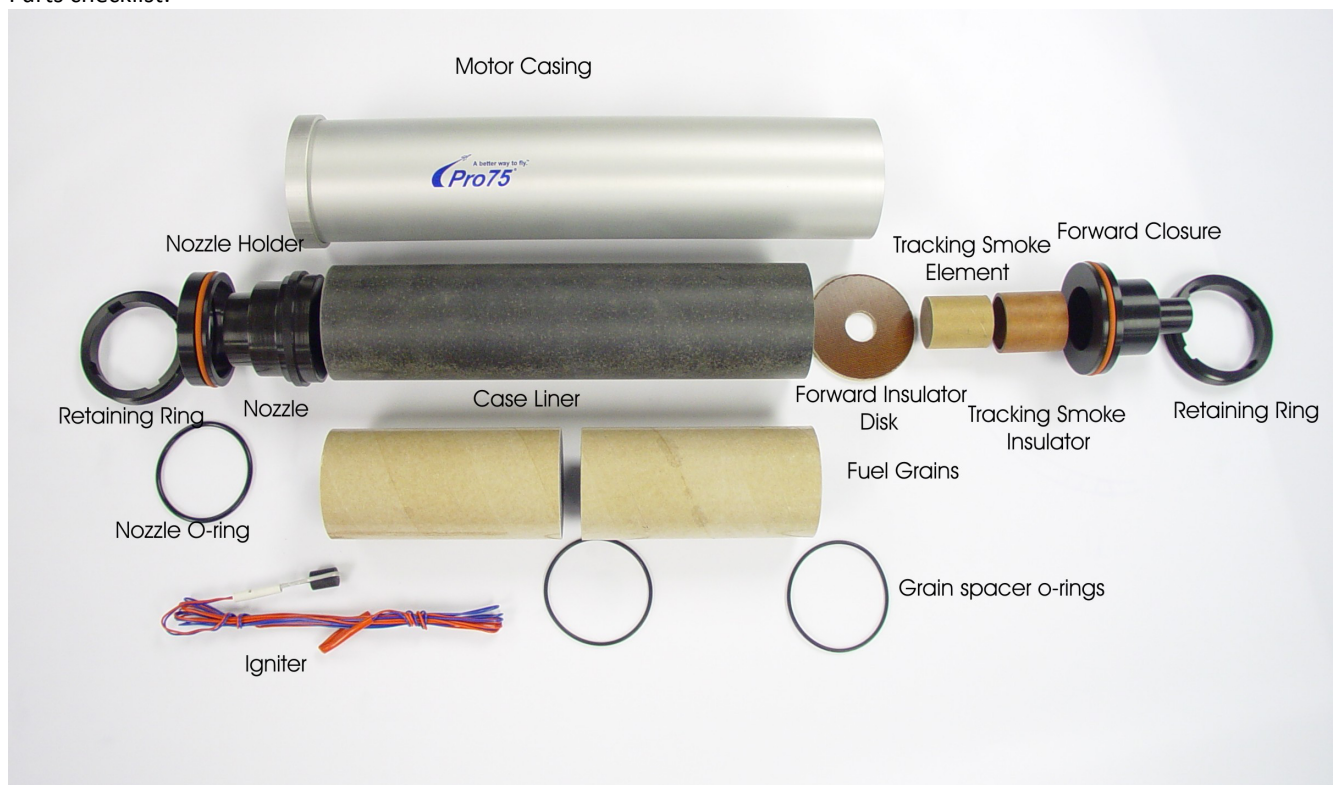

Pro75® hardware components (if used):

- ✓ Appropriate size of motor case
- ✓ Forward closure
- ✓ Nozzle holder
- ✓ Threaded retaining rings (2)

Reload kit components:

- ✓ Case liner (phenolic tube)
- ✓ Nozzle
- ✓ Forward insulator disk
- ✓ P75-ORK (o-ring kit)
- ✓ P75-TSI-KIT (smoke tracking grain/insulator & igniter kit)
- ✓ Propellant grains (check reload kit package for number and type required for your motor)

### Assembly instructions

- Be sure to follow the correct instructions for the brand of motor hardware you are using!
- Step 1 is the same for both brands of hardware.
- All o-rings are pre-lubricated at the factory where required.
- Three o-rings are supplied in the P75-ORK o-ring kits. The two larger o-rings are used with both Pro75® and RMS™ hardware. The smaller o-ring is only used with Pro75® hardware.
- Do not apply lubricant to the grain spacer o-rings, they are for spacing only.
- Phenolic and phenolic/paper components such as the nozzle and case liner tube are brittle and can be cracked, broken or otherwise damaged by excessive force or impact. Please be careful during handling and assembly. If you suspect a part has been damaged in any way, STOP and do not proceed with assembly and especially firing until inspected and replaced if necessary.

#### 1. Forward Closure Assembly

- 1.1. Apply a light coating of o-ring lubricant or grease to the inside of the cavity in the forward closure. Insert the smoke tracking charge insulator into this cavity and ensure it is seated fully.
- 1.2. Apply a liberal layer of grease or o-ring lubricant to one end of the smoke tracking grain. Be sure the entire face is coated.
- 1.3. Insert the smoke tracking grain into the smoke tracking charge insulator, coated end first. Push the grain in with sufficient force to fully seat it and spread the lubricant as shown. The excess lubricant will help prevent gas leakage forward as well as protecting the forward closure from heat and combustion products from the smoke tracking charge.

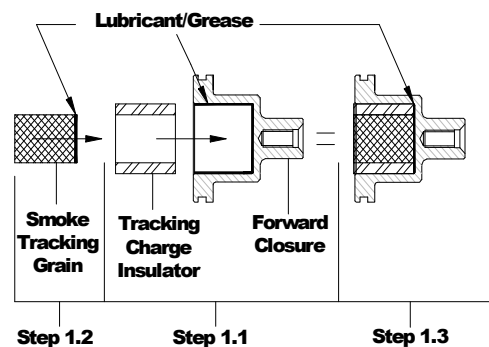

***You may now proceed to the remainder of the instructions for your brand of motor hardware.***

***Step 2 is for Pro75® hardware users.***

Step 3 is for RMS™ hardware users.

## 2. Motor Assembly: Pro75® Hardware.

Before proceeding, inspect the external o-ring grooves on the forward closure and nozzle holder, as well as the internal groove on the nozzle holder. Clean thoroughly if necessary to remove ALL combustion residue and debris. Also ensure that the inside of the motor case has been thoroughly cleaned.

- 2.1. Check both ends of the phenolic case liner to ensure that the inside ends have been chamfered or deburred. If not, use a hobby knife or coarse sandpaper to remove the sharp inner edge to allow components to be inserted easily.

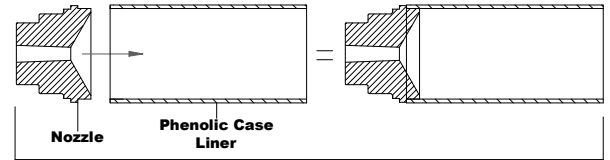

Step 2.1 & 2.2

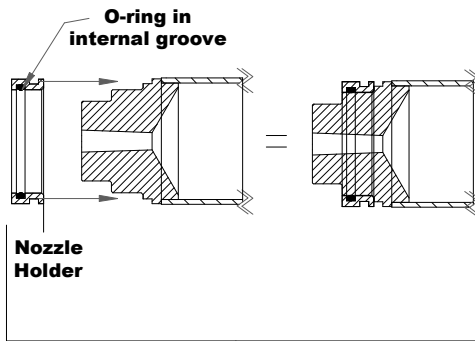

Step 2.3

- 2.2. Fit the nozzle to one end of the paper/phenolic case liner tube. It may be a snug fit. Push it carefully but with sufficient force to seat the shoulder on the nozzle all the way into the insulator tube.
- 2.3. Locate the smaller o-ring in the P75-ORK o-ring kit. Fit the o-ring to the internal groove of the nozzle holder. Push the nozzle holder over the nozzle until fully seated. Apply additional lubricant to the nozzle exit section if necessary to facilitate assembly.
- 2.4. For steps 2.5 – 2.6 work with the nozzle/case liner assembly and motor case horizontally on your work surface.

- 2.5. Insert one propellant grain into the forward end of the case liner and push it a short way into the tube. Fit one grain spacer o-ring to the top face of the grain, ensuring it sits flat on the end of the grain. Insert the second grain, push it in a short way, then add another grain spacer, and so on until you have loaded all propellant grains into the case liner.

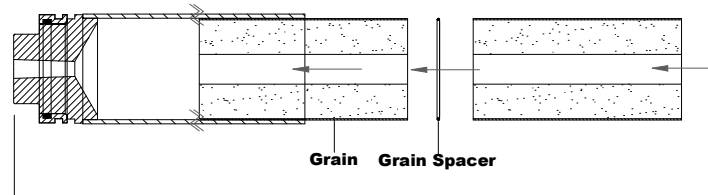

Step 2.5

- 2.5.1. There should be sufficient space after the last grain is inserted to fit the last spacer in place so that it is flush or extends only slightly from the end of the tube. If it extends out by more than 1/3 of its own thickness, remove it and do not use. Only this spacer may be omitted and only if necessary to fit.

- 2.6. Carefully install the two larger o-rings into the external grooves of the nozzle holder and forward closure. Handle these components with care from this point on so as not to damage or contaminate the o-rings.

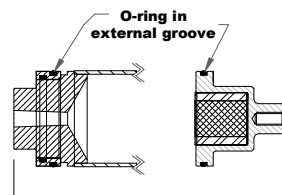

Step 2.6

- 2.7. Place the case liner/nozzle assembly on your work surface with the nozzle end down, and slide the motor case down rear end first (end with thrust ring) over the top of the liner towards the nozzle. **Note:** a light coat of grease on the liner exterior will aid assembly, disassembly and cleanup!

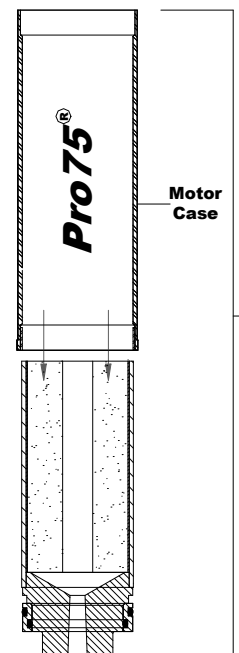

Step 2.7

- 2.8. Lay the motor case assembly down horizontally, and push on the nozzle ring until the assembly is far enough inside the case that the threads are partly exposed and the screw ring can be threaded into the rear of the case. Don't push on the nozzle itself as you will push it out of the nozzle holder.

- 2.9. Screw in the nozzle retaining ring using the supplied wrench, pushing the nozzle/nozzle ring/case liner assembly forward as you proceed. Screw it in *only until the retaining ring is*

exactly even with the end of the motor case - do not thread it in as far as it will go. Then, back the retaining ring out one half of a turn.

- 2.10. Fit the forward insulating disk to the top of the case liner, checking that the top grain spacer (if used) is still properly in place.

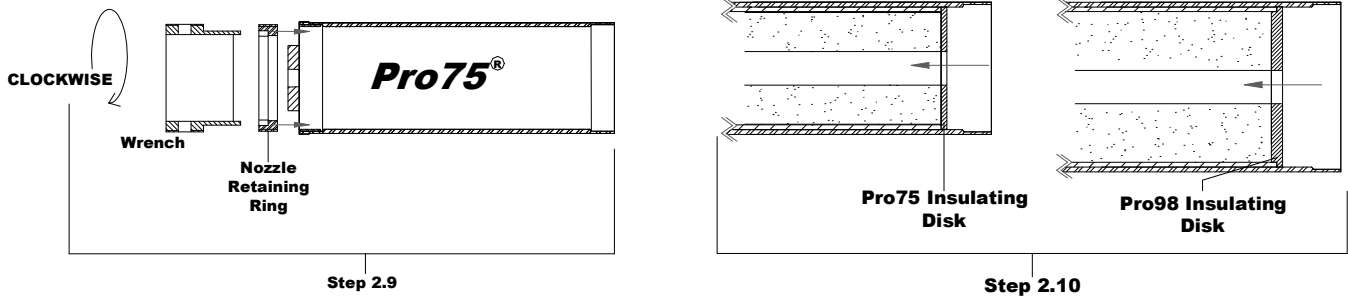

- 2.11. Verify that the inside of the motor case is clean ahead of the liner assembly before proceeding. Wipe with a clean rag, tissue or wet-wipe if required. Apply a light coat of silicone o-ring lubricant onto this area after cleaning.
- 2.12. Insert the assembled forward closure into the top of the motor case, pushing it down carefully with your fingers until you can thread in the retaining ring. Thread in the forward retaining ring using the wrench, until you feel it take up a load against the top of the case liner. At this point the ring should be approximately flush with the end of the motor case, or slightly submerged. If it extends out the case at this point by more than about one half a turn, check the nozzle end to make sure the ring is not screwed in too far forward. If so, unscrew the nozzle retaining ring another half turn and screw the forward closure retainer in further.

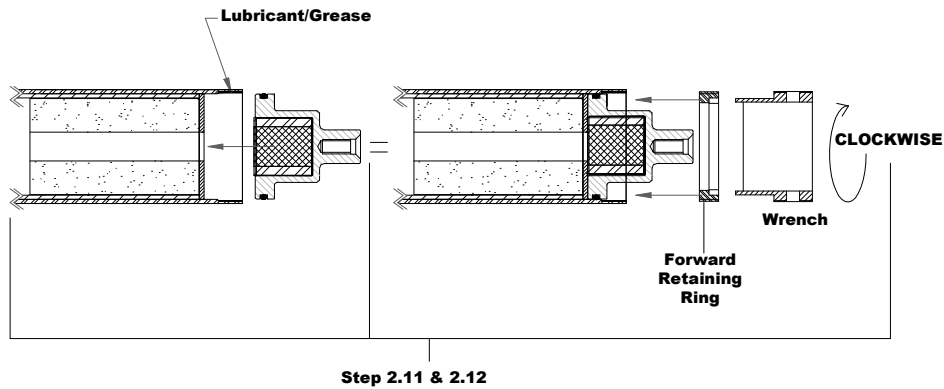

**NOTE:** it is best to have the forward closure retaining ring flush or slightly submerged and the nozzle retaining ring protruding by a half turn or so, than vice versa. There is more tolerance for o-ring location at the nozzle end. There will always be some minor variation in the length of internal components due to manufacturing tolerances.

- 2.13. Skip ahead to Section 4, Preflight preparation.

### 3. Motor Assembly, RMS™ Hardware.

- 3.1. Check both ends of the phenolic case liner to ensure that the inside ends have been chamfered or deburred. If not, use a hobby knife or coarse sandpaper to remove the sharp inner edge to allow components to be inserted easily.
- 3.2. Fit the nozzle to one end of the paper/phenolic case liner tube. It may be a snug fit. Push it carefully but with sufficient force to seat the shoulder on the nozzle all the way into the insulator tube.
- 3.3. For steps 3.4 – 3.8 work with the nozzle/case liner assembly and motor case horizontally on your work surface.

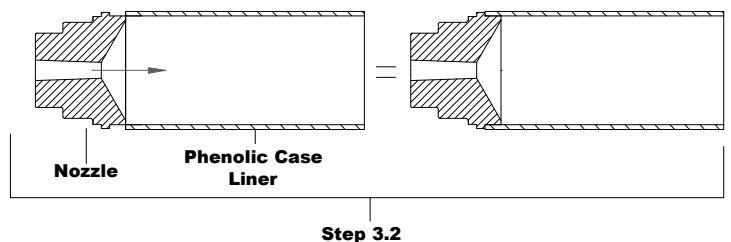

3.4. Insert one propellant grain into the forward end of the case liner and push it a short way into the tube. Fit one grain spacer o-ring to the top face of the grain, ensuring it sits flat on the end of the grain. Insert the second grain, push it in a short ways, then add another grain spacer, and so on until you have loaded all propellant grains into the case liner.

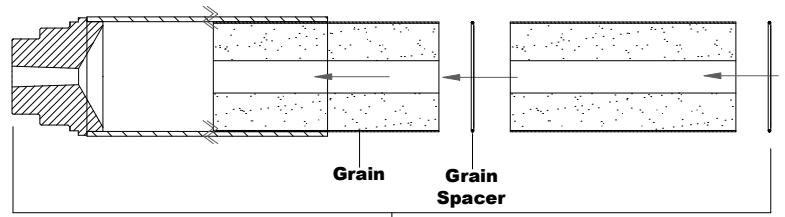

Step 3.4

3.4.1. There should be sufficient space after the last grain is inserted to fit the last spacer in place so that it is flush or extends only slightly from the end of the tube. If it extends out by more than 1/3 of its own thickness, remove it and do not use. Only this spacer may be omitted and only if necessary to fit.

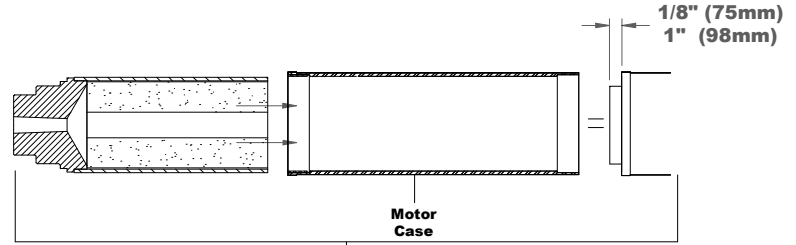

Step 3.5

3.5. Slide the completed liner/nozzle/grain assembly into the motor case until the nozzle protrudes about 1/8" from the end of the case. **Note:** a light coat of grease on the liner exterior will aid assembly, disassembly and cleanup!

3.6. Fit the forward insulating disk to the top of the case liner, checking that the top grain spacer (if used) is still properly in place.

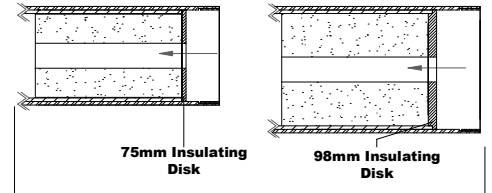

Step 3.6

3.7. Place one of the larger pre-lubricated o-rings from the P75-ORK kit into the forward end of the case until it is seated against the forward insulator.

3.8. Thread the completed forward closure into the forward end of the motor case by hand until it is seated against the case. **NOTE:** There will be considerable resistance to threading in the closure in the last 1/8" to 3/16" of travel, due to compression of the o-ring.

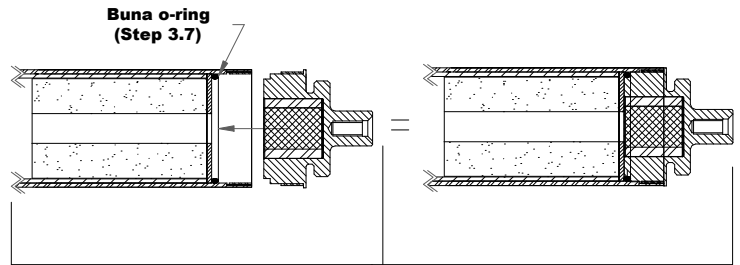

Step 3.7 & 3.8

3.9. Hold the motor vertically on your work surface with the forward closure downwards, and push down on the nozzle to ensure the liner/nozzle assembly is seated fully forward.

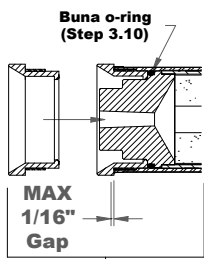

Step 3.10 & 3.11

3.10. Place the other identical o-ring into the groove in the nozzle.

3.11. Thread the aft closure into the motor case until it is seated. It is normal for a small gap (up to about 1/16") to remain between the closure and the end of the case, due to manufacturing tolerances on internal components. **Note:** There will be considerable resistance to threading in the closure in the last 1/8" to 3/16" of travel, due to compression of the o-ring.

3.12. Proceed to Section 4, Preflight preparation.

#### 4. Preflight Preparation.

- 4.1. Prepare the rocket's recovery system, before motor installation if possible.
- 4.2. Install the motor in your rocket, ensuring that it is securely mounted with a positive means of retention to prevent it from being ejected during any phase of the rocket's flight.
- 4.3. **IMPORTANT: DO NOT INSTALL THE IGNITER IN THE MOTOR UNTIL YOU HAVE THE ROCKET ON THE LAUNCH PAD, OR IN A SAFE AREA DESIGNATED BY THE RANGE SAFETY OFFICER.** Follow all rules and regulations of your rocketry association, and/or the National Fire Protection Association (NFPA) Code 1127 where applicable.
- 4.4. Install the supplied igniter, ensuring that it travels forward until it is in contact with the forward closure. Securely retain the igniter to the motor nozzle with tape, or (if supplied) the plastic cap, routing the wires through one of the vent holes. Ensure that whatever means you use provides a vent for igniter gases to prevent premature igniter ejection.
- 4.5. Launch the rocket in accordance with all Federal, State/Provincial, and municipal laws as well as the Safety Code of your rocketry association, as well as NFPA Code 1127 where applicable.

#### 5. Post Flight Cleanup.

Do not try to dismount or disassemble your motor until it has thoroughly cooled down after firing. Some components such as the nozzle may be extremely hot for some time after firing.

Perform motor cleanup as soon as possible after firing, however, as combustion residues are corrosive to motor components, and become very difficult to remove after several hours.

- 5.1. Unthread and remove the forward and rear closures. Remove the nozzle holder from the nozzle.
- 5.2. Remove the phenolic tracking smoke charge insulator from the forward closure.
- 5.3. Remove all o-rings.
- 5.4. Discard all reload kit components with regular household waste, after they have completely cooled down.
- 5.5. Use wet wipes, or paper towels or rags dampened with water or vinegar to thoroughly clean all residue, grease etc. off all hardware components. Pay close attention to internal and external o-ring grooves. A cotton swab or small stick of balsa is an excellent tool for cleaning these grooves.
- 5.6. Apply a light coat of grease or o-ring lubricant to all threaded sections and reassemble threaded components for storage.

**MEANS OF DISPOSAL:** The propellant grains, smoke tracking charge, and the igniter are extremely flammable and burn with an intense, hot flame. The remainder of the components are inert and may be disposed of with household trash. To destroy the flammable components, dig a shallow hole in the ground in a remote area, away from any buildings, trees, people, or any other combustibles. Place the propellant grains and smoke tracking module in the hole. Install the igniter into the core of one of the propellant grains and secure with tape. Ignite electrically from a minimum distance of 15 meters. Douse any smoldering paper residue and discard. Ensure that you are not in violation of any local or state regulations for this procedure. If in doubt, contact your local fire department. Please direct any questions regarding safe disposal to our technical support number on page one of this document.

**First Aid:** If ingested, induce vomiting. Burns from flames are to be treated as regular burns with normal first aid procedures. In either case, seek medical attention.

**Cesaroni Technology Incorporated ("CTI")** certifies that it has exercised reasonable care in the design and manufacture of its products. We do not assume any responsibility for product storage, transportation or usage. CTI shall not be held responsible for any personal injury or property damage resulting from the improper handling, storage or use of their products. The buyer assumes all risks and liabilities and accepts and uses CTI products on these conditions. No warranty either expressed or implied is made regarding **Pro75** products, except for replacement or repair, at CTI's option, of those products which are proven to be defective in manufacture within one (1) year from the date of original purchase. For repair or replacement under this warranty, please contact your point of purchase. Proof of purchase will be required. Your province or state may provide additional rights not covered by this warranty.

⇒ Check out our web site at <http://www.Pro-X.ca> for tech tips, FAQ's, user feedback and photos, or e-mail us at [ProX@cesaroni.net](mailto:ProX@cesaroni.net)  
⇒ For technical and warranty inquiries, please contact your Pro75<sup>®</sup> dealer.

Pro75<sup>®</sup> is a registered trademark of Cesaroni Technology Incorporated. Patent # US06079202. Other patents pending. Made in Canada.